

Dell Precision Workstation T1650 Owner's Manual

Regulatory Model: D09M
Regulatory Type: D09M004



Notes, Cautions, and Warnings



NOTE: A NOTE indicates important information that helps you make better use of your computer.



CAUTION: A CAUTION indicates either potential damage to hardware or loss of data and tells you how to avoid the problem.



WARNING: A WARNING indicates a potential for property damage, personal injury, or death.

© 2012 Dell Inc.

Trademarks used in this text: Dell™, the DELL logo, Dell Precision™, Precision ON™, ExpressCharge™, Latitude™, Latitude ON™, OptiPlex™, Vostro™, and Wi-Fi Catcher™ are trademarks of Dell Inc. Intel®, Pentium®, Xeon®, Core™, Atom™, Centrino®, and Celeron® are registered trademarks or trademarks of Intel Corporation in the U.S. and other countries. AMD® is a registered trademark and AMD Opteron™, AMD Phenom™, AMD Sempron™, AMD Athlon™, ATI Radeon™, and ATI FirePro™ are trademarks of Advanced Micro Devices, Inc. Microsoft®, Windows®, MS-DOS®, Windows Vista®, the Windows Vista start button, and Office Outlook® are either trademarks or registered trademarks of Microsoft Corporation in the United States and/or other countries. Blu-ray Disc™ is a trademark owned by the Blu-ray Disc Association (BDA) and licensed for use on discs and players. The Bluetooth® word mark is a registered trademark and owned by the Bluetooth® SIG, Inc. and any use of such mark by Dell Inc. is under license. Wi-Fi® is a registered trademark of Wireless Ethernet Compatibility Alliance, Inc.

2012 – 05

Rev. A00

Contents

Notes, Cautions, and Warnings.....	2
1 Working on Your Computer.....	5
Before Working Inside Your Computer.....	5
Turning Off Your Computer.....	6
After Working Inside Your Computer.....	6
2 Removing and Installing Components.....	7
Recommended Tools.....	7
Removing the Cover.....	7
Installing the Cover.....	7
Removing the Intrusion Switch.....	8
Installing the Intrusion Switch.....	8
Removing the Front Panel.....	9
Installing the Front Panel.....	10
Removing the Expansion Card.....	10
Installing the Expansion Card.....	11
Memory Module Guidelines.....	11
Removing the Memory.....	11
Installing the Memory.....	11
Removing the Coin-Cell Battery.....	12
Installing the Coin-Cell Battery.....	12
Removing the Hard Drive.....	12
Installing the Hard Drive.....	13
Removing the Optical Drive.....	13
Installing the Optical Drive.....	15
Removing the Speakers.....	15
Installing the Speakers.....	16
Removing the Power Supply.....	16
Installing the Power Supply.....	19
Removing the Heat Sink.....	19
Installing the Heat Sink.....	20
Removing the Processor.....	21
Installing the Processor.....	21
Removing the System Fan.....	21
Installing the System Fan.....	22
Removing the Thermal Sensor.....	22

Installing the Front Thermal Sensor.....	24
Removing the Power Switch.....	24
Installing the Power Switch.....	27
Removing the Input/Output (I/O) Panel.....	27
Installing the Input/Output (I/O) Panel.....	29
Removing the System Board.....	29
Installing the System Board.....	31
System Board Components.....	32
3 System Setup.....	33
Boot Sequence.....	33
Navigation Keys.....	33
System Setup Options.....	34
Updating the BIOS	40
Jumper Settings.....	40
System and Setup Password.....	41
Assigning a System Password and Setup Password.....	41
Deleting or Changing an Existing System and/or Setup Password.....	42
Disabling a System Password.....	42
4 Diagnostics.....	43
Enhanced Pre-Boot System Assessment (ePSA) Diagnostics.....	43
5 Troubleshooting Your Computer.....	45
Power LED Diagnostics.....	45
Beep Code.....	46
Error Messages.....	46
6 Technical Specifications.....	49
7 Contacting Dell	55

Working on Your Computer

Before Working Inside Your Computer

Use the following safety guidelines to help protect your computer from potential damage and to help to ensure your personal safety. Unless otherwise noted, each procedure included in this document assumes that the following conditions exist:

- You have read the safety information that shipped with your computer.
- A component can be replaced or--if purchased separately--installed by performing the removal procedure in reverse order.

 **WARNING:** Before working inside your computer, read the safety information that shipped with your computer. For additional safety best practices information, see the Regulatory Compliance Homepage at www.dell.com/regulatory_compliance

 **CAUTION:** Many repairs may only be done by a certified service technician. You should only perform troubleshooting and simple repairs as authorized in your product documentation, or as directed by the online or telephone service and support team. Damage due to servicing that is not authorized by Dell is not covered by your warranty. Read and follow the safety instructions that came with the product.

 **CAUTION:** To avoid electrostatic discharge, ground yourself by using a wrist grounding strap or by periodically touching an unpainted metal surface, such as a connector on the back of the computer.

 **CAUTION:** Handle components and cards with care. Do not touch the components or contacts on a card. Hold a card by its edges or by its metal mounting bracket. Hold a component such as a processor by its edges, not by its pins.

 **CAUTION:** When you disconnect a cable, pull on its connector or on its pull-tab, not on the cable itself. Some cables have connectors with locking tabs; if you are disconnecting this type of cable, press in on the locking tabs before you disconnect the cable. As you pull connectors apart, keep them evenly aligned to avoid bending any connector pins. Also, before you connect a cable, ensure that both connectors are correctly oriented and aligned.

 **NOTE:** The color of your computer and certain components may appear differently than shown in this document.

To avoid damaging your computer, perform the following steps before you begin working inside the computer.

1. Ensure that your work surface is flat and clean to prevent the computer cover from being scratched.
2. Turn off your computer (see Turning Off Your Computer).

 **CAUTION:** To disconnect a network cable, first unplug the cable from your computer and then unplug the cable from the network device.

3. Disconnect all network cables from the computer.
4. Disconnect your computer and all attached devices from their electrical outlets.
5. Press and hold the power button while the computer is unplugged to ground the system board.
6. Remove the cover.

CAUTION: Before touching anything inside your computer, ground yourself by touching an unpainted metal surface, such as the metal at the back of the computer. While you work, periodically touch an unpainted metal surface to dissipate static electricity, which could harm internal components.

Turning Off Your Computer

CAUTION: To avoid losing data, save and close all open files and exit all open programs before you turn off your computer.

1. Shut down the operating system:

– In Windows 7:

Click **Start** , then click **Shut Down**.

– In Windows Vista:

Click **Start** , then click the arrow in the lower-right corner of the **Start** menu as shown below, and then click **Shut Down**.



– In Windows XP:

Click **Start** → **Turn Off Computer** → **Turn Off**. The computer turns off after the operating system shutdown process is complete.

2. Ensure that the computer and all attached devices are turned off. If your computer and attached devices did not automatically turn off when you shut down your operating system, press and hold the power button for about 6 seconds to turn them off.

After Working Inside Your Computer

After you complete any replacement procedure, ensure you connect any external devices, cards, and cables before turning on your computer.

1. Replace the cover.

CAUTION: To connect a network cable, first plug the cable into the network device and then plug it into the computer.

2. Connect any telephone or network cables to your computer.

3. Connect your computer and all attached devices to their electrical outlets.

4. Turn on your computer.

5. If required, verify that the computer works correctly by running the Dell Diagnostics.

Removing and Installing Components

This section provides detailed information on how to remove or install the components from your computer.

Recommended Tools

The procedures in this document may require the following tools:

- Small flat-blade screwdriver
- Phillips screwdriver
- Small plastic scribe

Removing the Cover

1. Follow the procedures in *Before Working Inside Your Computer*.
2. Pull up the cover release latch, and lift the cover upwards to remove it from the computer.

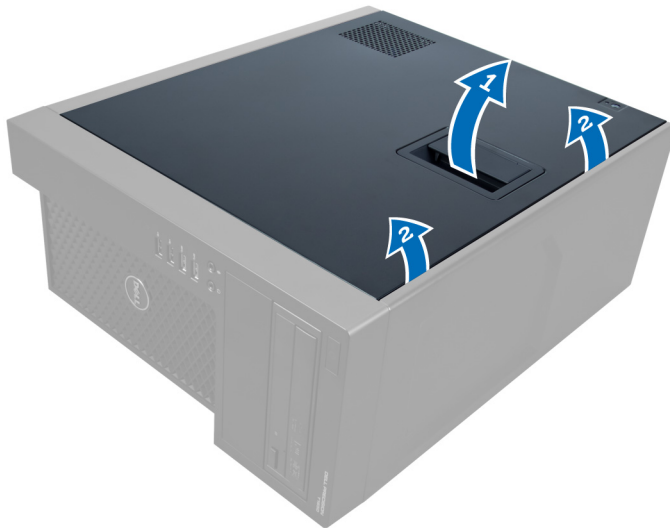

Figure 1.

Installing the Cover

1. Place the cover on the computer.
2. Press down on the cover till it clicks into place.
3. Follow the procedures in *After Working Inside Your Computer*.

Removing the Intrusion Switch

1. Follow the procedures in *Before Working Inside Your Computer*.
2. Remove the cover.
3. Press the clip inwards to release and disconnect the intrusion cable from system board.

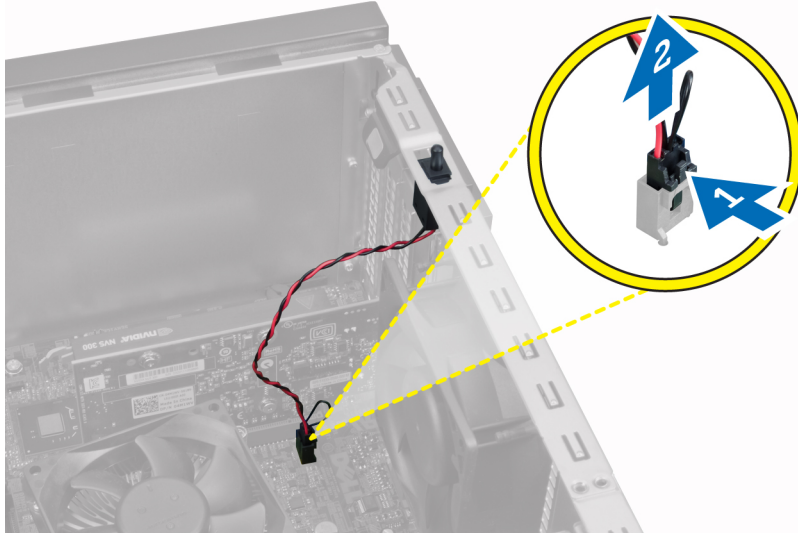

Figure 2.

4. Slide the intrusion switch toward the chassis bottom and remove it from the chassis.



Figure 3.

Installing the Intrusion Switch

1. Insert the intrusion switch into the slot on the back of the chassis and slide it out to secure it.
2. Connect the intrusion cable to the system board.

3. Install the cover.
4. Follow the procedures in *After Working Inside Your Computer*.

Removing the Front Panel

1. Follow the procedures in *Before Working Inside Your Computer*.
2. Remove the cover.
3. Pry the front panel retention clips away from the chassis located at the edge of front panel.



Figure 4.

4. Rotate the front panel away from the computer chassis. Lift the chassis to release the hooks on the other side of the panel and remove the front panel from the computer.

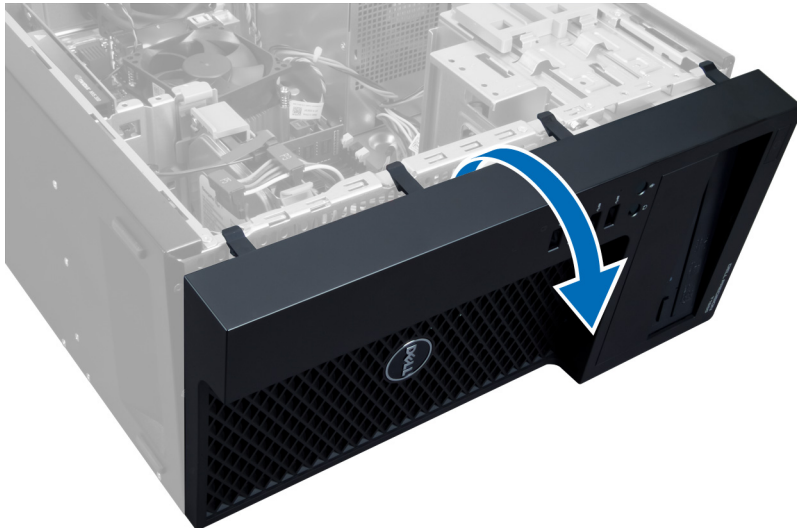

Figure 5.

Installing the Front Panel

1. Insert the hooks along the bottom edge of the front panel into the slots on the chassis front.
2. Push the panel towards the computer chassis to engage the front-panel retention clips, until they click into place.
3. Install the cover.
4. Follow the procedures in *After Working Inside Your Computer*.

Removing the Expansion Card

1. Follow the procedures in *Before Working Inside Your Computer*.
2. Remove the cover.
3. Press the card-retention latch and pull the latch outwards on the other side.

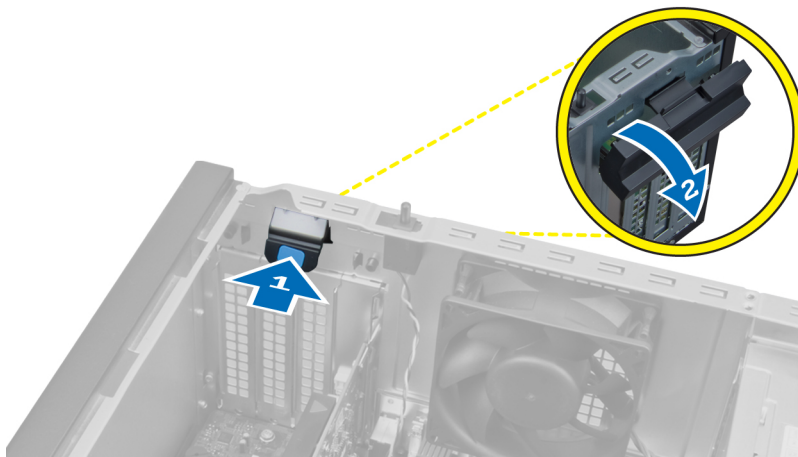

Figure 6.

4. Release the retention-clip away from the expansion card. Then, ease the card up and out of its slot and remove it from the computer.

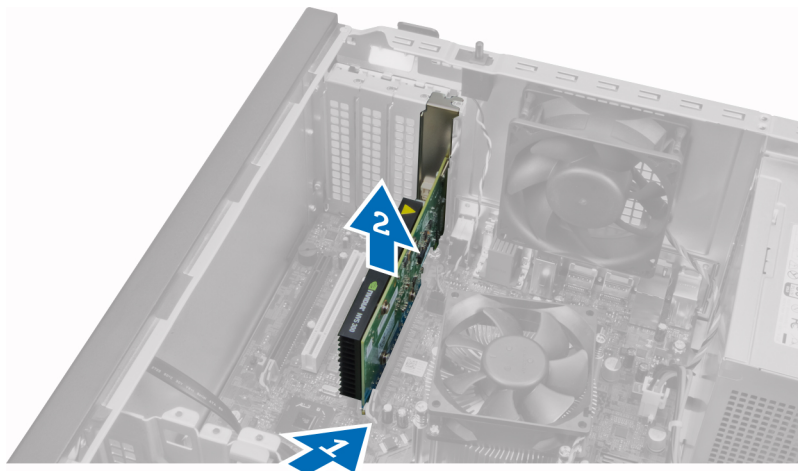

Figure 7.

Installing the Expansion Card

1. Insert the expansion card into the slot on the system board and press down until the dent in the card settles on the slot correctly.
2. Push the card retention clip inward, until it clicks to secure the card.
3. Install the cover.
4. Follow the procedures in *After Working Inside Your Computer*.

Memory Module Guidelines

To ensure optimal performance of your computer, observe the following general guidelines when configuring your system memory:

- Memory modules of different sizes can be mixed (for example, 2 GB and 4 GB), but all populated channels must have identical configurations.
- Memory modules must be installed beginning with the first socket.

 **NOTE:** The memory sockets in your computer may be labelled differently depending on the hardware configuration. For example, A1, A2 or 1,2,3.

- If the quad-rank memory modules are mixed with single or dual-rank modules, the quad-rank modules must be installed in the sockets with the white release levers.
- If memory modules with different speeds are installed, they operate at the speed of the slowest installed memory module(s).

Removing the Memory

1. Follow the procedures in *Before Working Inside Your Computer*.
2. Remove the cover.
3. Press down on the memory retention-clips on each side of the memory module, and lift the memory module out of the socket on the system board.

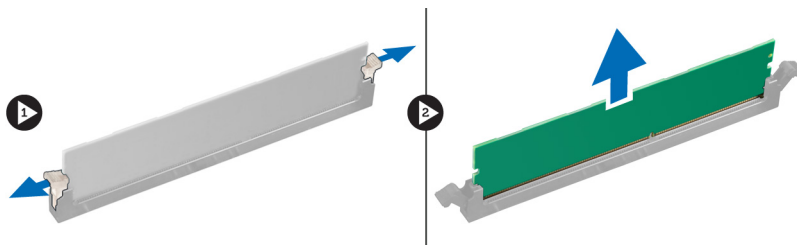



Figure 8.

Installing the Memory

1. Insert the memory module into the socket on the system board.

 **NOTE:** Memory module must be installed beginning with the white tabbed sockets first.

2. Press down on the memory module until the retention-clips spring back to secure them in place.
3. Install the cover.
4. Follow the procedures in *After Working Inside Your Computer*.

Removing the Coin-Cell Battery

1. Follow the procedures in *Before Working Inside Your Computer*.
2. Remove the:
 - a) cover
 - b) expansion card(s)
3. Press the release latch away from the battery to allow the battery to pop-up from the socket and lift the coin-cell battery out of the computer.

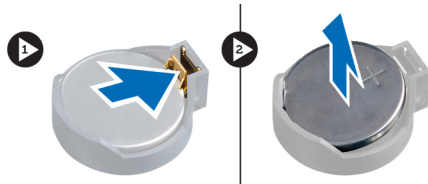

Figure 9.

Installing the Coin-Cell Battery

1. Place the coin-cell battery into its slot on the system board.
2. Press the coin-cell battery downward until the release latch springs back into place and secures it.
3. Install the:
 - a) expansion card(s)
 - b) cover
4. Follow the procedures in *After Working Inside Your Computer*.

Removing the Hard Drive

1. Follow the procedures in *Before Working Inside Your Computer*.
2. Remove the cover.
3. Disconnect and remove the data and the power cables from the back of the hard drive.



4. Press the securing tabs inward and lift the hard-drive bracket out of the drive bay.

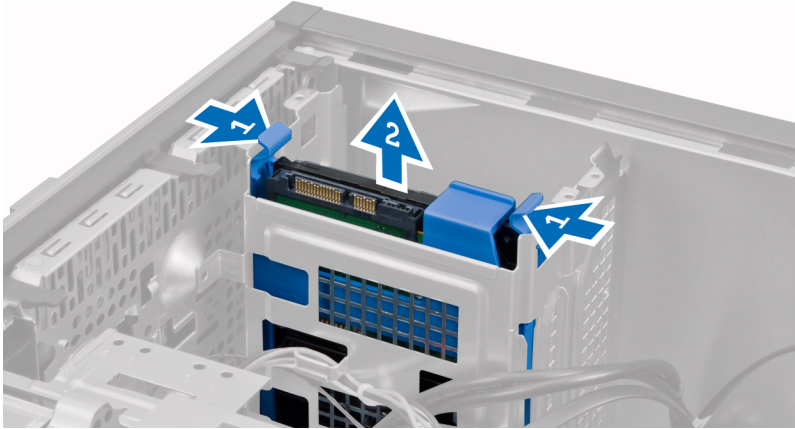

5. Flex the hard-drive bracket and remove the hard drive from the bracket.

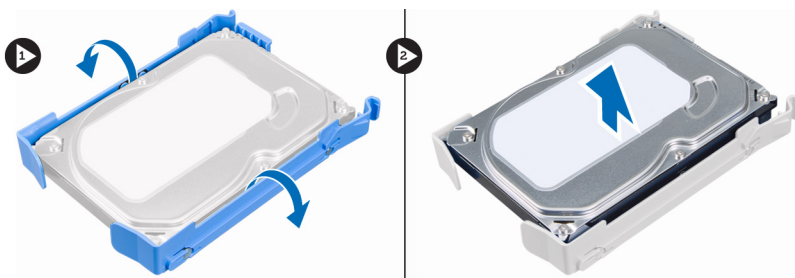

6. Repeat the steps 3 to 5 to remove the second hard drive, if available.

Installing the Hard Drive

1. Insert the hard drive into the hard-drive bracket.
2. Press both the securing tabs inward and slide the hard-drive bracket into the bay.
3. Connect the data and power cables to the back of the hard drive.
4. Install the cover.
5. Follow the procedures in *After Working Inside Your Computer*.

Removing the Optical Drive

1. Follow the procedures in *Before Working Inside Your Computer*.
2. Remove the:
 - a) cover
 - b) front panel
3. Disconnect the data cable and the power cables from the back of the optical drive.

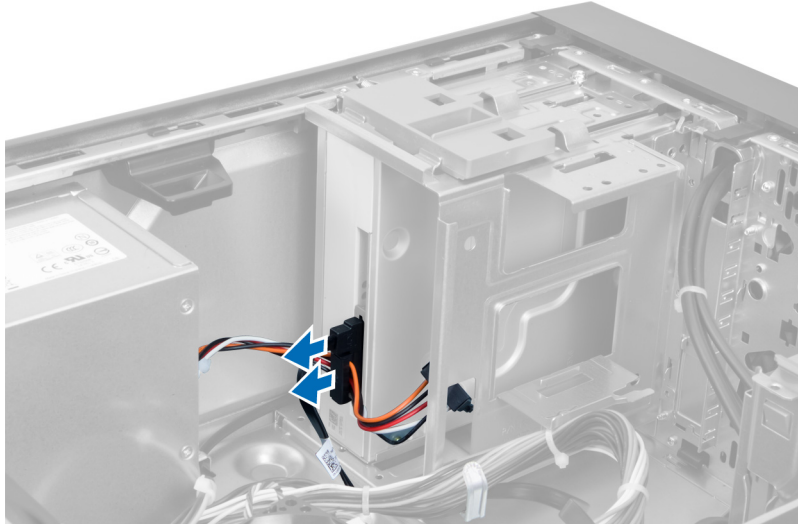

Figure 10.

4. Slide down the optical drive latch to release the optical drive.

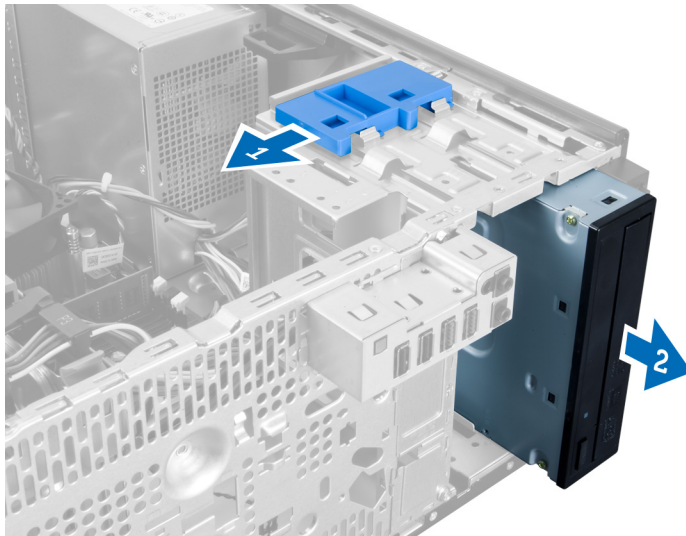

Figure 11.

5. Pull the optical drive out from the computer.

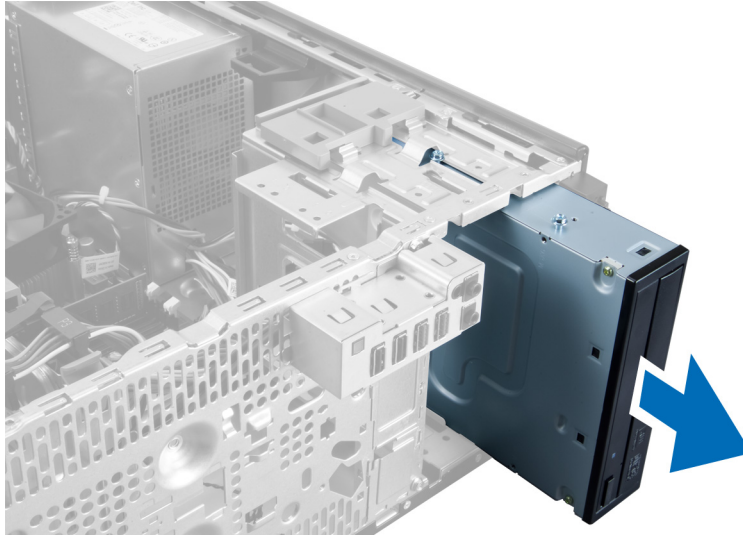

Figure 12.

6. Repeat steps 4 to 6 to remove the second optical drive (if available).

Installing the Optical Drive

1. Slide the optical drive inside the drive bay, until the latch secures the drive.
2. Connect the data cable and power cables to the back of the optical drive.
3. Install the:
 - a) front panel
 - b) cover
4. Follow the procedures in *After Working Inside Your Computer*.

Removing the Speakers

1. Follow the procedures in *Before Working Inside Your Computer*.
2. Remove the cover.
3. Disconnect the speaker cable from the system board and release the cable from the chassis clip.

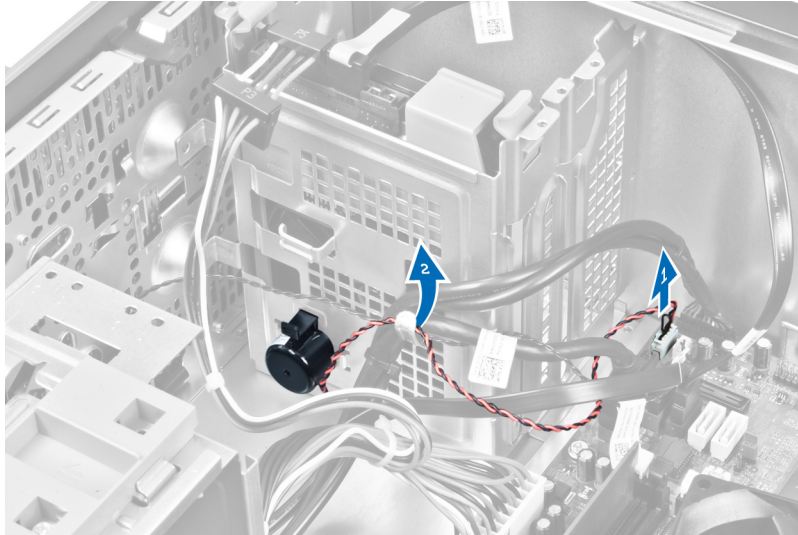

4. Press down the speaker-securing tab and slide the speaker upwards to remove it.

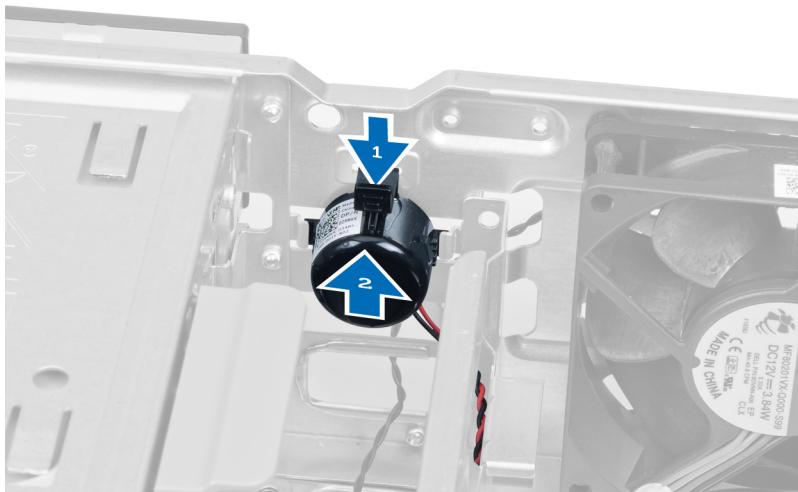

Installing the Speakers

1. Secure the speaker, by sliding it into the slot.
2. Thread the cable into the chassis clip and connect the speaker cable to the system board.
3. Replace the cover.
4. Follow the procedures in *After Working Inside Your Computer*.

Removing the Power Supply

1. Follow the procedures in *Before Working Inside Your Computer*.
2. Remove the cover.
3. Disconnect and release and the cables from the optical drive(s).



Figure 13.

4. Disconnect the cable(s) from the hard drive and remove the cables from the clips.

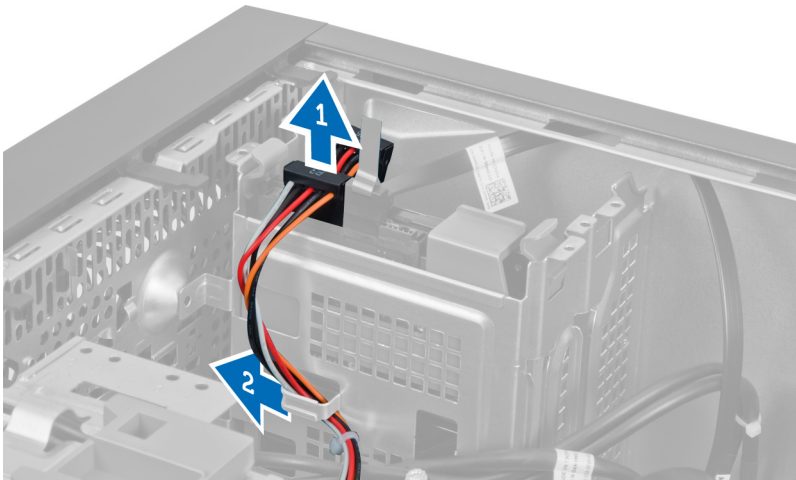

Figure 14.

5. Press the clip and disconnect the 24-pin cable from the system board.

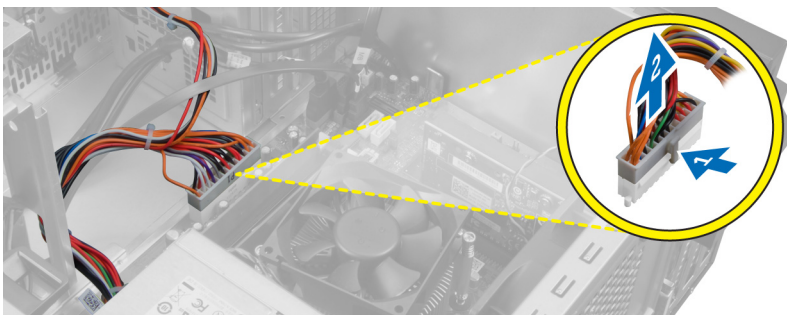

Figure 15.

6. Remove the screws that secure the power supply unit to the computer.

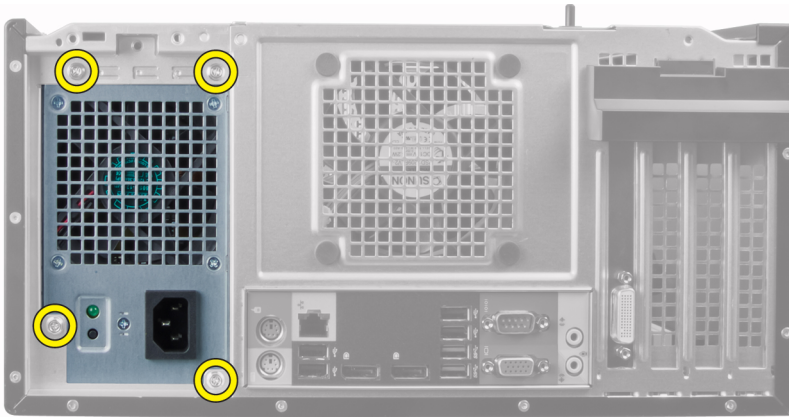

Figure 16.

7. Press the release tab at the bottom of the power supply and slide the power supply towards the front of the computer.



Figure 17.

8. Lift the power supply out of the computer.



Figure 18.

Installing the Power Supply

1. Place the power supply in the chassis and slide towards the back of the computer to secure it.
2. Tighten the screws to secure the power supply to the back of the computer.
3. Connect the 24-pin power cable to the system board.
4. Thread the power cables into the chassis clips.
5. Connect the power cables to the hard drive(s) and optical drive(s).
6. Install the cover.
7. Follow the procedures in *After Working Inside Your Computer*.

Removing the Heat Sink

1. Follow the procedures in *Before Working Inside Your Computer*.
2. Remove the cover.
3. Press the clip to release and disconnect the heat-sink cable from the system board.

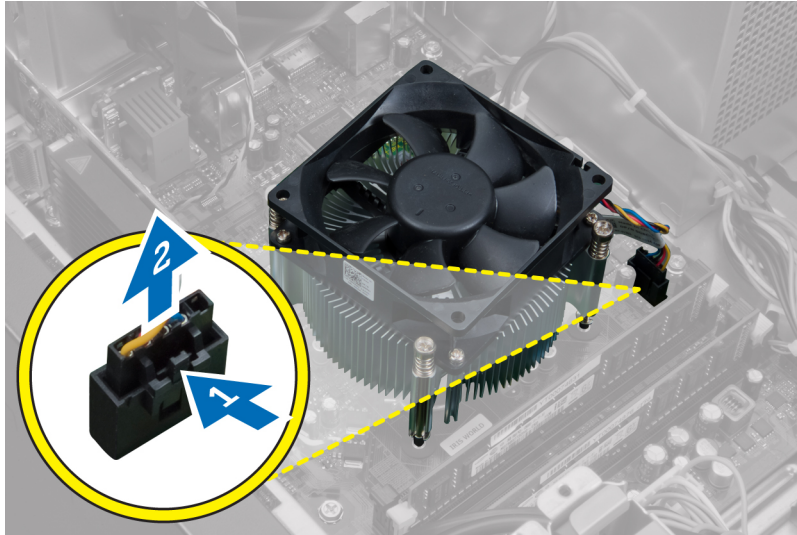

Figure 19.

4. Loosen the captive screws that secure the heat sink to the system board and lift the heat sink away from the computer.

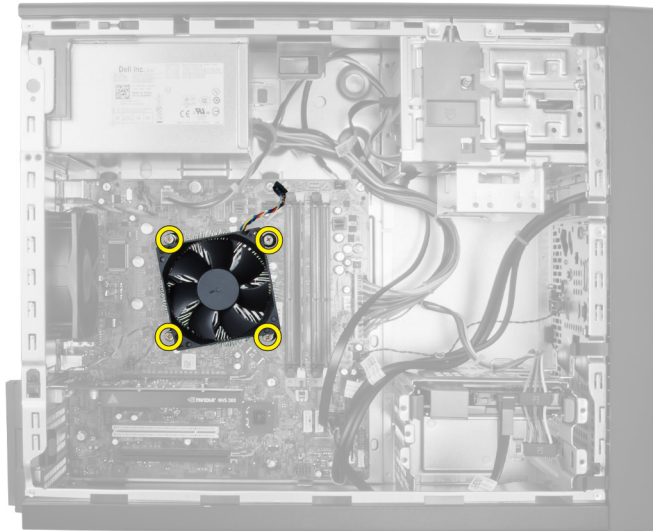

Figure 20.

Installing the Heat Sink

1. Place the heat sink into the chassis.
2. Tighten the captive screws to secure the heat sink to the system board.
3. Connect the heat sink cable to the system board.
4. Install the cover.
5. Follow the procedures in *After Working Inside Your Computer*.

Removing the Processor

1. Follow the procedures in *Before Working Inside Your Computer*.
2. Remove the:
 - a) cover
 - b) heat sink
3. Press the release lever down and then move it outward to release it from the retention hook. Lift the processor cover and remove the processor from the socket, and place it in an antistatic bag.



Installing the Processor

1. Insert the processor into the processor socket. Ensure that the processor is properly seated.
2. Lower the processor cover.
3. Press the release lever down and then move it inward to secure it with the retention hook.
4. Install the:
 - a) heat sink
 - b) cover
5. Follow the procedures in *After Working Inside Your Computer*.

Removing the System Fan

1. Follow the procedures in *Before Working Inside Your Computer*.
2. Remove the cover.
3. Press the clip to release and disconnect the system fan cable from the system board.

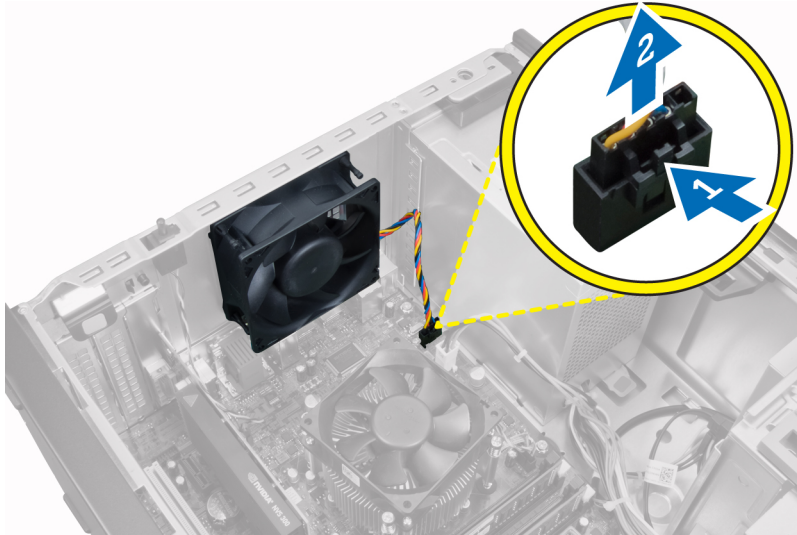

4. Pry and remove the system fan away from the grommets securing it to the back of the computer.

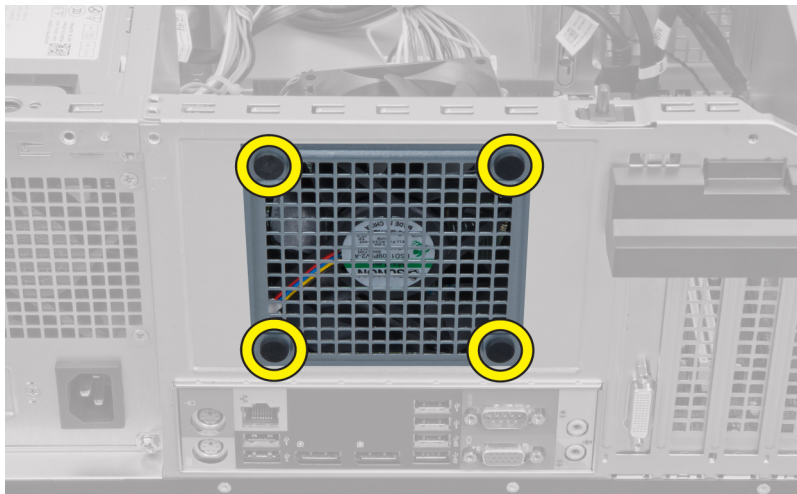

Installing the System Fan

1. Place the chassis fan in the chassis.
2. Insert the grommets through the fan vent and slide outward along the groove to secure in place.
3. Connect the fan cable to the system board.
4. Install the cover.
5. Follow the procedures in *After Working Inside Your Computer*.

Removing the Thermal Sensor

1. Follow the procedures in *Before Working Inside Your Computer*.
2. Remove the cover.
3. Disconnect the thermal sensor cable from the system board.

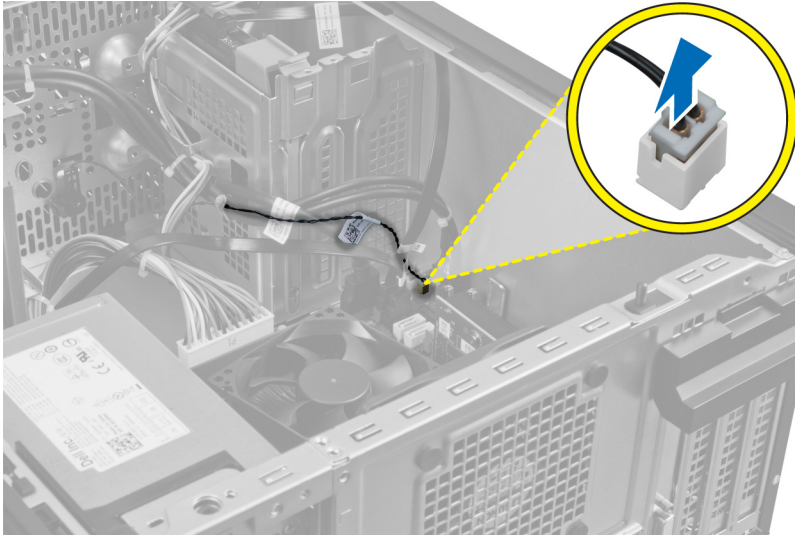

4. Release the thermal sensor cable from the chassis clip.

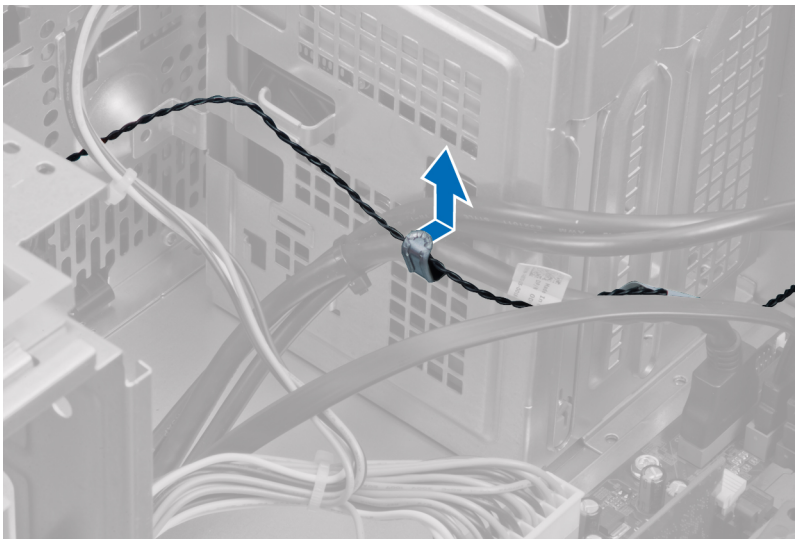

5. Press the tabs from both sides to release and remove the thermal sensor away from the chassis.

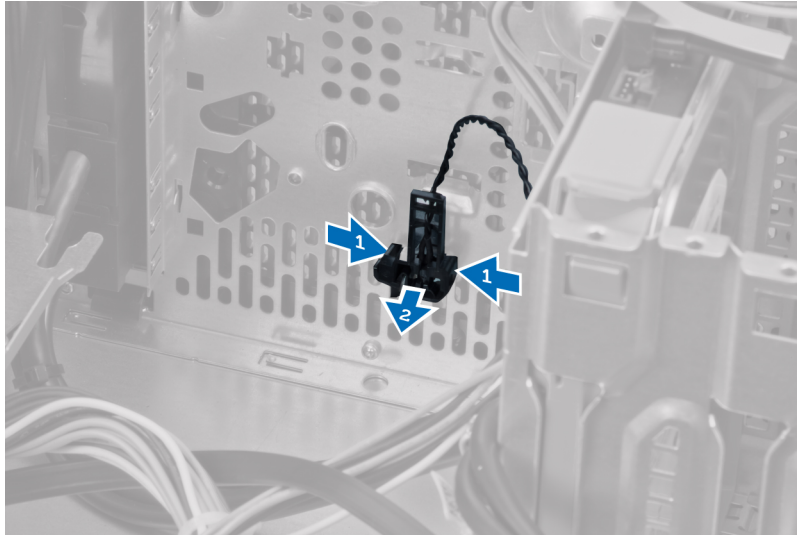

Installing the Front Thermal Sensor

1. Secure the thermal sensor to the slot in the chassis.
2. Thread the thermal sensor cable into the chassis clip.
3. Connect the thermal sensor cable to the system board.
4. Install the cover.
5. Follow the procedures in *After Working Inside Your Computer*.

Removing the Power Switch

1. Follow the procedures in *Before Working Inside Your Computer*.
2. Remove the:
 - a) cover
 - b) front panel
 - c) optical drive
3. Press in on the clip to release and disconnect the power-switch cable from the system board.

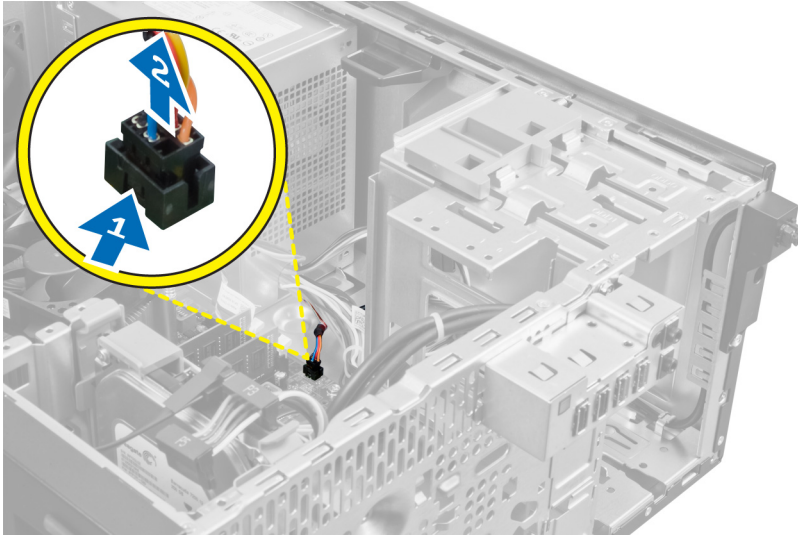

4. Release the power-switch cable from the chassis clips.

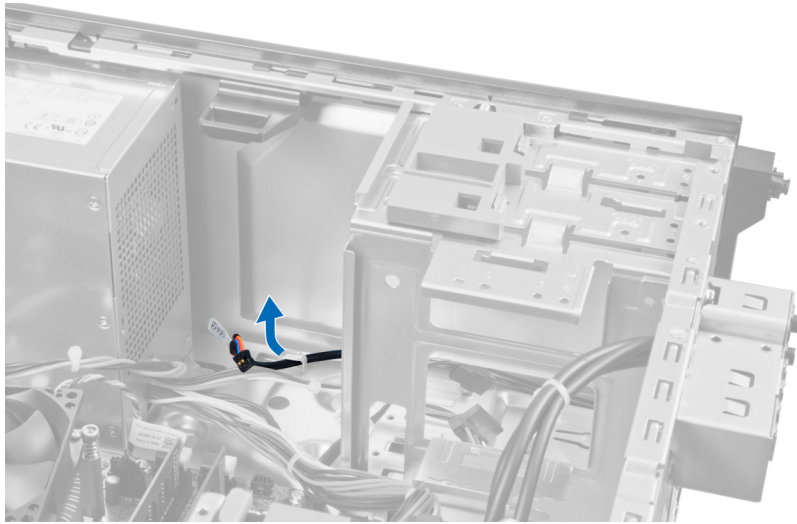

5. Press the clips on both side of the power switch to release it from the chassis and pull the power switch out of the computer. Slide the power switch along with its cable out through the front of the computer.

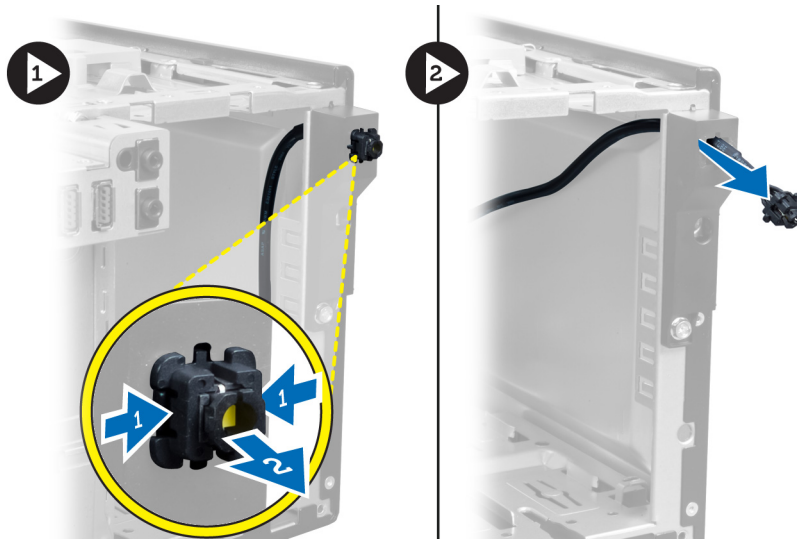

Installing the Power Switch

1. Slide the power-switch cable in through the front of the computer.
2. Secure the power-switch cable to the chassis.
3. Thread the power-switch cable into the chassis clips.
4. Connect the power-switch cable to the system board.
5. Install the:
 - a) optical drive
 - b) front panel
 - c) cover
6. Follow the procedures in *After Working Inside Your Computer*.

Removing the Input/Output (I/O) Panel

1. Follow the procedures in *Before Working Inside Your Computer*.
2. Remove the:
 - a) cover
 - b) front panel
3. Disconnect the I/O panel and FlyWire cable from the system board.

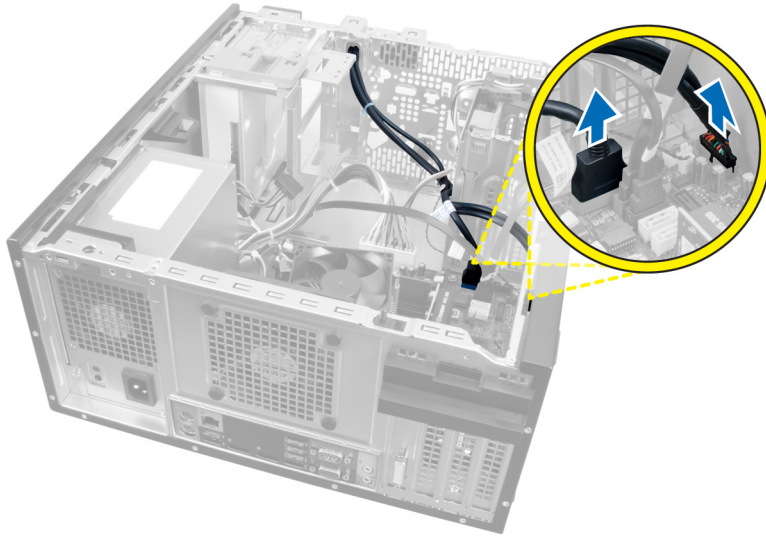

Figure 21.

4. Remove the screw that secures the I/O panel to the computer.

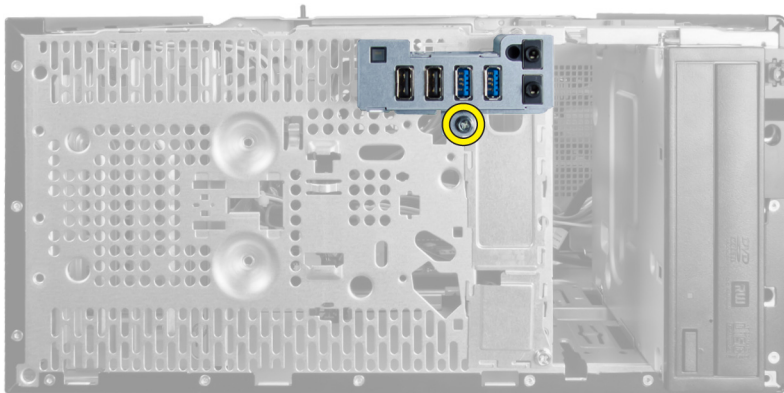

Figure 22.

5. Slide the I/O panel towards the left of the computer to release it and pull the I/O panel along with its cable out of the computer.

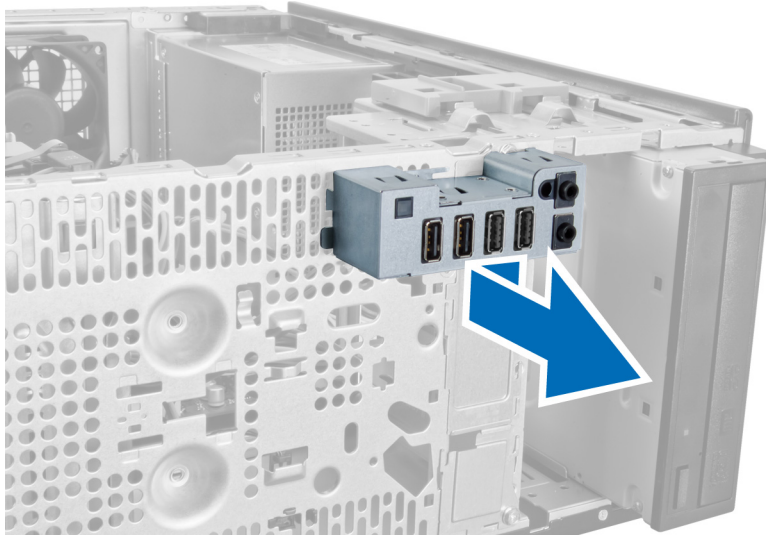

Figure 23.

Installing the Input/Output (I/O) Panel

1. Insert the I/O panel into the slot on the chassis front.
2. Slide the I/O panel towards the right of the computer to secure to the chassis.
3. Tighten the screw to secure the I/O panel to the chassis.
4. Thread the I/O panel/FlyWire cable into the chassis clip.
5. Connect the I/O panel/FlyWire cable to the system board.
6. Install the:
 - a) front panel
 - b) cover
7. Follow the procedures in *After Working Inside Your Computer*.

Removing the System Board

1. Follow the procedures in *Before Working Inside Your Computer*.
2. Remove the:
 - a) cover
 - b) front panel
 - c) expansion card(s)
 - d) heat sink
 - e) processor
3. Disconnect all the cables connected to the system board.

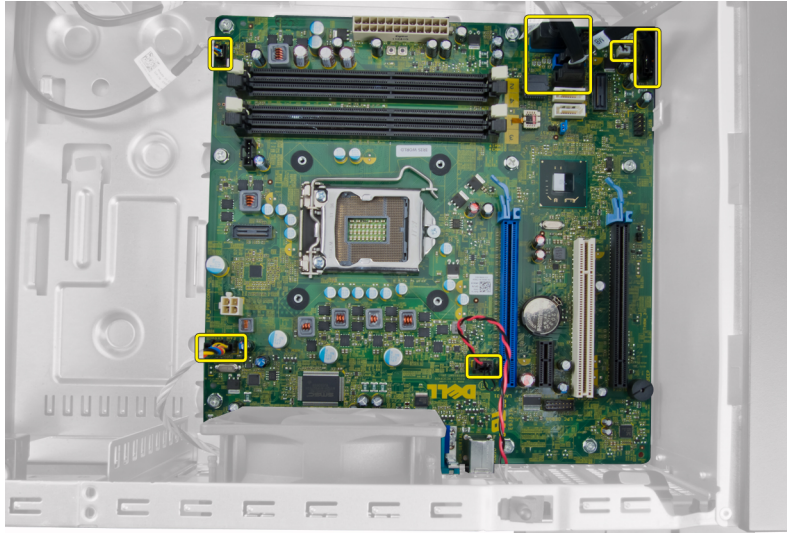

4. Remove the screws that secure the system board to the computer.



5. Slide the system board towards the front of the computer.

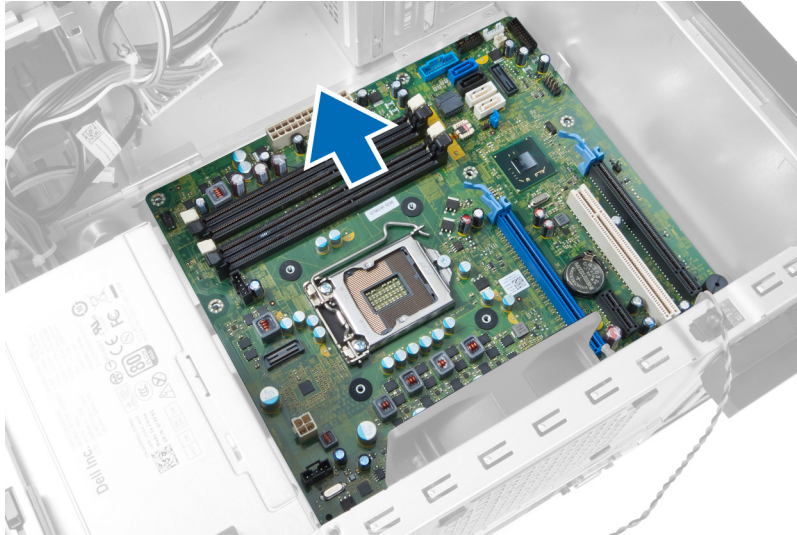

6. Tilt the system board to 45–degrees, and lift the system board out of the computer.

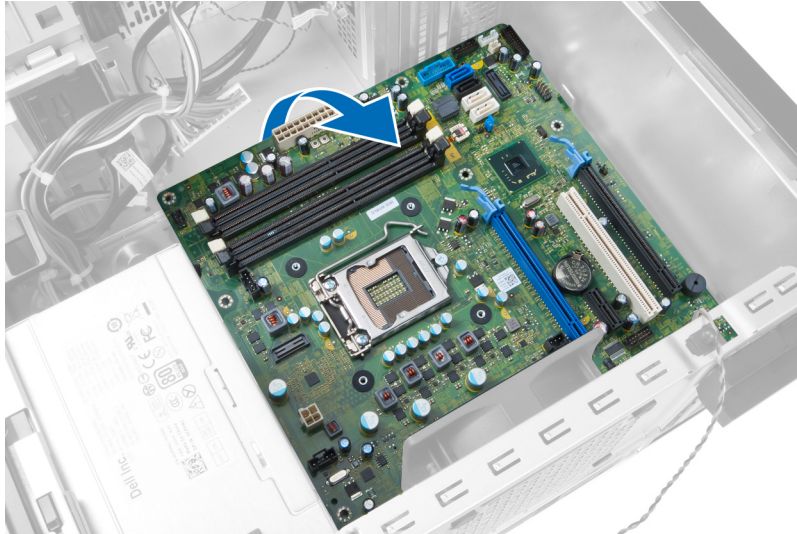

Installing the System Board

1. Align the system board to the port connectors on the rear of the chassis and place the system board in the chassis.
2. Tighten the screws to secure the system board to the chassis.
3. Connect the cables to the system board.
4. Install the:
 - a) processor
 - b) heat sink
 - c) expansion card(s)
 - d) front panel
 - e) cover
5. Follow the procedures in *After Working Inside Your Computer*.

System Board Components

The following image displays the system board components.

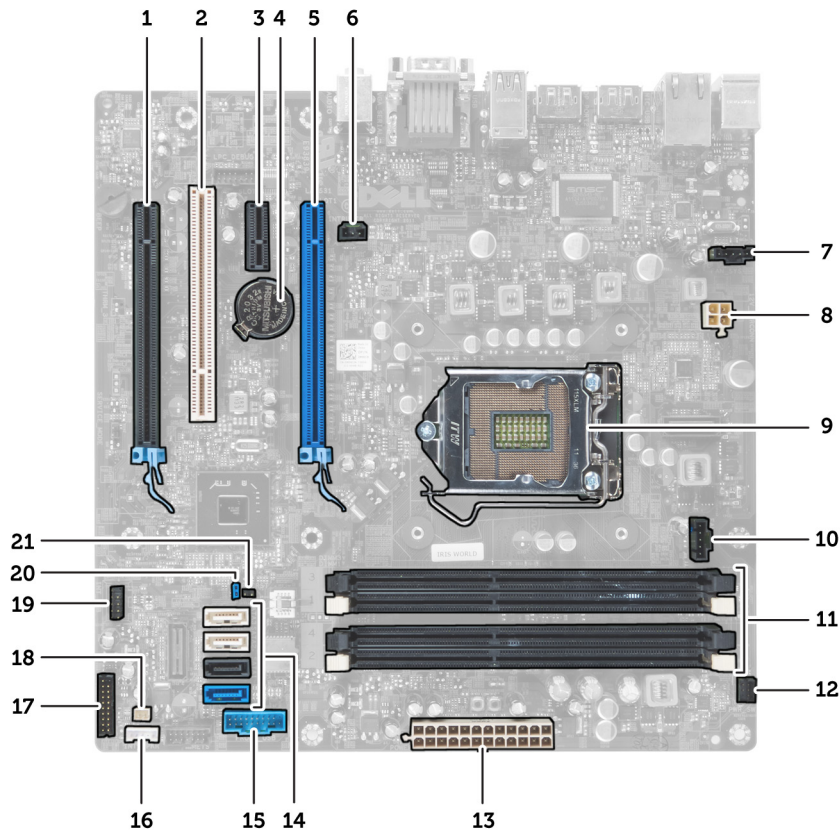

Figure 24.

- | | |
|--|--|
| 1. PCI Express x16 (wired as x4) connector | 12. Power Switch Connector (PWR_SW) |
| 2. PCI Card connector | 13. System Power Connector (Mini_PWR) |
| 3. PCI Express x1 Card connector | 14. SATA Drive Connectors |
| 4. Coin-Cell Battery socket | 15. Front USB |
| 5. PCI Express x16 card connector | 16. Internal Speaker Connector |
| 6. Intruder Connector (Intruder) | 17. Front-Panel Connector (FrontPanel) |
| 7. Fan Connector (Fan_SYS) | 18. Thermal Sensor Connector |
| 8. Power connector (12V_PWRCONN) | 19. Internal USB Connector (INT_USB) |
| 9. Processor | 20. Password Jumper (PSWD) |
| 10. Fan Connector (Fan_CPU) | 21. RTC reset jumper (RTC_RST) |
| 11. Memory Module Connectors (DIMM_1-4) | |

System Setup

System Setup enables you to manage your computer hardware and specify BIOS-level options. From the System Setup, you can:

- Change the NVRAM settings after you add or remove hardware
- View the system hardware configuration
- Enable or disable integrated devices
- Set performance and power management thresholds
- Manage your computer security

Boot Sequence

Boot Sequence allows you to bypass the System Setup-defined boot device order and boot directly to a specific device (for example: optical drive or hard drive). During the Power-on Self Test (POST), when the Dell logo appears, you can:

- Access System Setup by pressing <F2> key
- Bring up the one-time boot menu by pressing <F12> key

The one-time boot menu displays the devices that you can boot from including the diagnostic option. The boot-menu options are:

- Removable Drive (if available)
- STXXXX Drive

 **NOTE:** XXX denotes the SATA drive number.

- Optical Drive
- Diagnostics

 **NOTE:** Choosing Diagnostics, will display the **ePSA diagnostics** screen.

The boot sequence screen also displays the option to access the System Setup screen.

Navigation Keys

The following table displays the system setup navigation keys.



 **NOTE:** For most of the system setup options, changes that you make are recorded but do not take effect until you restart the system.

Table 1. Navigation Keys

Keys	Navigation
Up arrow	Moves to the previous field.
Down arrow	Moves to the next field.

Keys	Navigation
<Enter>	Allows you to select a value in the selected field (if applicable) or follow the link in the field.
Spacebar	Expands or collapses a drop-down list, if applicable.
<Tab>	Moves to the next focus area.
	 NOTE: For the standard graphics browser only.
<Esc>	Moves to the previous page till you view the main screen. Pressing <Esc> in the main screen displays a message that prompts you to save any unsaved changes and restarts the system.
<F1>	Displays the System Setup help file.

System Setup Options





 **NOTE:** Depending on the computer and its installed devices, the items listed in this section may or may not appear

Table 2. General

Option	Description
System Information	This section lists the primary hardware features of your computer. <ul style="list-style-type: none"> • System Information • Device Information • PCI Information • Memory Information • Processor Information
Boot Sequence	Allows you to specify the order in which the computer attempts to find an operating system. The options are: <ul style="list-style-type: none"> • Diskette drive • ST320LT007-9ZV142 / ST3250312AS • USB Storage Device • CD/DVD/CD-RW Drive • Onboard NIC
Boot List Option	Allows you to change the boot list option. <ul style="list-style-type: none"> • Legacy • UEFI
Date/Time	Allows you to set the date and time. The changes to the system date and time takes effect immediately.

Table 3. System Configuration

Option	Description
Integrated NIC	Allows you to enable or disable the integrated network card. You can set the integrated NIC to: <ul style="list-style-type: none"> • Disabled • Enabled (Default Setting)

Option	Description
Serial Port	<ul style="list-style-type: none"> • Enabled w/PXE <p> NOTE: Depending on the computer and its installed devices, the items listed in this section may or may not appear.</p> <p>Allows you to define the serial port settings. You can set the serial port to:</p> <ul style="list-style-type: none"> • Disabled • COM1 (Default Setting) • COM2 • COM3 • COM4 <p> NOTE: The operating system may allocate resources even though the setting is disabled.</p>
SATA Operation	<p>Allows you to configure the operating mode of the integrated hard drive controller.</p> <ul style="list-style-type: none"> • Disabled - The SATA controllers are hidden. • ATA - SATA is configured for ATA mode. • AHCI (Default Setting) - SATA is configured for AHCI mode. • RAID ON - SATA is configured to support RAID mode.
Drives	<p>Allows you to enable or disable the various on-board drives:</p> <ul style="list-style-type: none"> • SATA-0 • SATA-1 • SATA-2 • SATA-3
SMART Reporting	<p>Default Setting: All drives are enabled.</p> <p>This field controls if the hard drive errors for the integrated drives are reported during system startup. This technology is part of the SMART (Self Monitoring Analysis and Reporting Technology) specification.</p> <ul style="list-style-type: none"> • Enable SMART Reporting - This option is disabled by default.
USB Configuration	<p>This field configures the integrated USB controller. If Boot Support is enabled, the system is allowed to boot any type of USB mass storage devices (HDD, memory key, floppy).</p> <p>If USB port is enabled, device attached to this port is enabled and available for operation system.</p> <p>If USB port is disabled, the operation system cannot see any device attached to this port.</p> <ul style="list-style-type: none"> • Enable Boot Support • Enable Rear Dual USB Ports • Enable Front USB Ports • Enable Rear Quad USB Ports <p> NOTE: USB keyboard and mouse always work in the BIOS setup irrespective of these settings.</p>

Option	Description
Miscellaneous Devices	Allows you to enable or disable various on-board devices. <ul style="list-style-type: none"> • Enable PCI Slot - This option is enabled by default.

Table 4. Security

Option	Description
Admin Password	This field lets you set, change, or delete the administrator (admin) password (sometimes called the setup password). The admin password enables several security features. The drive does not have a password set by default. <ul style="list-style-type: none"> • Enter the old password • Enter the new password • Confirm the new password
System Password	Allows you to set, change, or delete the computer password (previously called the primary password). The drive does not have a password set by default. <ul style="list-style-type: none"> • Enter the old password • Enter the new password • Confirm the new password
Internal HDD-0 Password	Allows you to set, change, or delete the password on the computer's internal hard disk drive (HDD). Successful changes to this password take effect immediately. The drive does not have a password set by default. <ul style="list-style-type: none"> • Enter the old password • Enter the new password • Confirm the new password
Strong Password	Enable strong password - This option is disabled by default.
Password Configuration	This field controls the minimum and maximum number of characters allowed for the admin and system passwords. <ul style="list-style-type: none"> • Admin Password Min • Admin Password Max • System Password Min • System Password Max
Password Bypass	Allows you to bypass the System Password and the internal HDD password prompts during a system restart. <ul style="list-style-type: none"> • Disabled - Always prompt for the system and internal HDD password when they are set. This option is disabled by default. • Reboot Bypass - Bypass the password prompts on restarts (warm boots). <p> NOTE: The system will always prompt for the system and internal HDD passwords when powered on from the off state (a cold boot). Also, the system will always prompt for passwords on any module bay HDDs that may be present.</p>



Option	Description
Password Change	<p>Allows you to determine whether changes to the system and hard disk passwords are permitted when an administrator password is set.</p> <ul style="list-style-type: none"> • Allow Non-Admin Password Changes - This option is enabled by default.
TPM Security	<p>This option lets you control whether the Trusted Platform Module (TPM) in the system is enabled and visible to the operating system.</p> <p>TPM Security - This option is disabled by default.</p> <p> NOTE: Activation, deactivation, and clear options are not affected if you load the setup program's default values. Changes to this option take effect immediately.</p>
Computrace(R)	<p>This field lets you activate or disable the BIOS module interface of the optional Computrace Service from Absolute Software.</p> <ul style="list-style-type: none"> • Deactivate - This option is disabled by default. • Disable • Activate
CPU XD Support	<p>Allows you to enable or disable the execute disable mode of the processor.</p> <ul style="list-style-type: none"> • Enable CPU XD Support - This option is enabled by default.
OROM Keyboard Access	<p>Allows you to determine if you access the Option Read Only Memory (OROM) configuration screens via hotkeys during boot. These settings prevent access to the Intel RAID (CTRL+I) or Intel Management Engine BIOS Extension (CTRL+P/F12).</p> <ul style="list-style-type: none"> • Enable - User may enter OROM configuration screens via the hotkey. • One-Time Enable - User can enter the OROM configuration screens via the hotkeys during the next boot. After the boot, the setting will revert to disabled. • Disable - User can not enter the OROM configuration screens via the hotkey. <p>This option is set to Enable by default.</p>
Admin Setup Lockout	<p>Allows you to enable or disable the option to enter setup when an admin password is set.</p> <ul style="list-style-type: none"> • Enable Admin Setup Lockout - This option is not set by default.

Table 5. Performance

Option	Description
Multi Core Support	<p>Specifies whether the process will have one or all cores enabled. The performance of some applications will improve with the additional cores.</p> <ul style="list-style-type: none"> • All - Enabled by default • 1 • 2
Intel® SpeedStep™	<p>Allows you to enable or disable the Intel SpeedStep mode of the processor. This option is enabled by default.</p>
C States Control	<p>Allows you to enable or disable the additional processor sleep states. This option is enabled by default.</p>

Option	Description
Intel® TurboBoost™	<p>Allows you to enable or disable <i>Intel TurboBoost</i> mode of the processor.</p> <ul style="list-style-type: none"> • Disabled - Does not allow the TurboBoost driver to increase the performance state of the processor above the standard performance. • Enabled - Allows the Intel TurboBoost driver to increase the performance of the CPU or graphics processor.
Hyper-Thread Control	Allows you to enable or disable the Hyper-Threading technology. This option is disabled by default.

Table 6. Power Management

Option	Description
AC Recovery	<p>Specifies how the computer will respond when AC power is applied after a AC power loss. You can set the AC Recovery to:</p> <ul style="list-style-type: none"> • Power Off (default) • Power On • Last Power State
Auto On Time	<p>This option sets the time of the day when you would like the system to turn on automatically. Time is kept in standard 12-hour format (hour:minutes:seconds). The startup time can be changed by typing the values in the time and A.M./P.M. fields.</p> <ul style="list-style-type: none"> • Disabled - The system will not automatically power up. • Every Day - The system will power up every day at the time you specified above . • Weekdays - The system will power up Monday through Friday at the time you specified above. • Select Days - The system will power up on days selected above at the time you specified above. <p> NOTE: This feature does not work if you turn off your computer using the switch on a power strip or surge protector or if Auto Power is set to disabled.</p>
Deep Sleep Control	<p>Allows you to define the controls when Deep Sleep is enabled.</p> <ul style="list-style-type: none"> • Disabled • Enabled in S5 only • Enabled in S4 and S5 <p>This option is disabled by default.</p>
Fan Control Override	<p>Controls the speed of the system fan. This option is disabled by default.</p> <p> NOTE: When enabled, the fan runs at full speed.</p>
USB Wake Support	<p>This option allows you to enable USB devices to wake the computer from standby.</p> <ul style="list-style-type: none"> • Enable USB Wake Support - This option is disabled by default.
Wake on LAN	<p>This option allows the computer to power up from the off state when triggered by a special LAN signal. Wake-up from the Standby state is unaffected by this setting and must be enabled in the operating system. This feature only works when the computer is connected to AC power supply.</p>

Option	Description
	<ul style="list-style-type: none"> • Disabled - Does not allow the system to power on by special LAN signals when it receives a wake-up signal from the LAN or wireless LAN. • LAN Only - Allows the system to be powered on by special LAN signals. <p>This option is Disabled by default.</p>
Block Sleep	<p>This option lets you block entering to sleep (S3 state) in operating system environment.</p> <ul style="list-style-type: none"> • Block Sleep (S3 state) - This option is disabled by default.

Table 7. POST Behavior

Option	Description
Numlock LED	Specifies if the NumLock function can be enabled when the system boots. This option is enabled by default.
Keyboard Errors	Specifies whether keyboard related errors are reported when it boots. This option is enabled by default.
POST Hotkeys	<p>Specifies whether the sign-on screen displays a message, that displays the keystroke sequence required to enter the BIOS Boot Option Menu.</p> <ul style="list-style-type: none"> • Enable F12 Boot Option menu - This option is enabled by default.

Table 8. Virtualization Support

Option	Description
Virtualization	<p>This option specifies whether a Virtual Machine Monitor (VMM) can utilize the additional hardware capabilities provided by Intel Virtualization technology.</p> <ul style="list-style-type: none"> • Enable Intel Virtualization Technology - This option is enabled by default.
VT for Direct I/O	<p>Enables or disables the Virtual Machine Monitor (VMM) from utilizing the additional hardware capabilities provided by Intel® Virtualization technology for direct I/O.</p> <ul style="list-style-type: none"> • Enable Intel Virtualization Technology for Direct I/O - This option is enabled by default.
Trusted Execution	<p>This option specifies whether a Measured Virtual Machine Monitor (MVMM) can utilize the additional hardware capabilities provided by Intel Trusted Execution technology. The TPM virtualization technology, and Virtualization technology for direct I/O must be enabled to use this feature.</p> <ul style="list-style-type: none"> • Trusted Execution - This option is disabled by default.

Table 9. Maintenance

Option	Description
Service Tag	Displays the service tag of your computer.
Asset Tag	Allows you to create a system asset tag if an asset tag is not already set. This option is not set by default.



Option	Description
SERR Messages	Controls the SERR message mechanism. This option is not set by default. Some graphics cards require that the SERR message mechanism be disabled.

Table 10. System Logs

Option	Description
BIOS events	Displays the system event log and allows you to clear the log. <ul style="list-style-type: none"> • Clear Log

Updating the BIOS

It is recommended to update your BIOS (system setup), on replacing the system board or if an update is available. For notebooks, ensure that your computer battery is fully charged and connected to a power outlet

1. Restart the computer.
2. Go to support.dell.com/support/downloads.
3. If you have your computer's Service Tag or Express Service Code:
 -  **NOTE:** For desktops, the service tag label is available on the front of your computer.
 -  **NOTE:** For notebooks, the service tag label is available on the bottom of your computer.
 - a) Enter the **Service Tag** or **Express Service Code** and click **Submit**.
 - b) Click **Submit** and proceed to step 5.
4. If you do not have your computer's service tag or express service code, select one of the following:
 - a) **Automatically detect my Service Tag for me**
 - b) **Choose from My Products and Services List**
 - c) **Choose from a list of all Dell products**
5. On the application and drivers screen, under the **Operating System** drop-down list, select **BIOS**.
6. Identify the latest BIOS file and click **Download File**.
7. Select your preferred download method in the **Please select your download method below window**; click **Download Now**.
The **File Download** window appears.
8. Click **Save** to save the file on your computer.
9. Click **Run** to install the updated BIOS settings on your computer.
Follow the instructions on the screen.

Jumper Settings

Jumper Settings allow you to reset the BIOS/system password or reset the real-time clock. To identify the type of jumper, see System Board Components. The following table displays the jumper settings for PSWD and RTCRST jumpers.

Table 11. Jumper Settings

Jumper	Setting	Description
PSWD	Default	Password features are enabled

RTCRST

pin 1 and 2

Real-time clock reset. This feature can be used for troubleshooting.

System and Setup Password

You can create a system password and a setup password to secure your computer.

Password Type	Description
---------------	-------------

System password	Password that you must enter to log on to your system.
------------------------	--

Setup password	Password that you must enter to access and make changes to the BIOS settings of your computer.
-----------------------	--

 **CAUTION:** The password features provide a basic level of security for the data on your computer.

 **CAUTION:** Anyone can access the data stored on your computer if it is not locked and left unattended.

 **NOTE:** Your computer is shipped with the system and setup password feature disabled.

Assigning a System Password and Setup Password

You can assign a new **System Password** and/or **Setup Password** or change an existing **System Password** and/or **Setup Password** only when **Password Status** is **Unlocked**. If the Password Status is **Locked**, you cannot change the System Password.

 **NOTE:** If the password jumper is disabled, the existing System Password and Setup Password is deleted and you need not provide the system password to log on to the computer.

To enter a system setup, press <F2> immediately after a power-on or reboot.

1. In the **System BIOS** or **System Setup** screen, select **System Security** and press <Enter>. The **System Security** screen appears.
2. In the **System Security** screen, verify that **Password Status** is **Unlocked**.
3. Select **System Password**, enter your system password, and press <Enter> or <Tab>. Use the following guidelines to assign the system password:
 - A password can have up to 32 characters.
 - The password can contain the numbers 0 through 9.
 - Only lower case letters are valid, upper case letters are not allowed.
 - Only the following special characters are allowed: space, ("), (+), (,), (-), (.), (/), (:), (|), (\), (|), (^).

Re-enter the system password when prompted.

4. Type the system password that you entered earlier and click **OK**.
5. Select **Setup Password**, type your system password and press <Enter> or <Tab>. A message prompts you to re-type the setup password.
6. Type the setup password that you entered earlier and click **OK**.
7. Press <Esc> and a message prompts you to save the changes.
8. Press <Y> to save the changes. The computer reboots.

Deleting or Changing an Existing System and/or Setup Password

Ensure that the **Password Status** is Unlocked (in the System Setup) before attempting to delete or change the existing System and/or Setup password. You cannot delete or change an existing System or Setup password, if the **Password Status** is Locked.

To enter the System Setup, press <F2> immediately after a power-on or reboot.

1. In the **System BIOS** or **System Setup** screen, select **System Security** and press <Enter>. The **System Security** screen is displayed.
2. In the **System Security** screen, verify that **Password Status** is **Unlocked**.
3. Select **System Password**, alter or delete the existing system password and press <Enter> or <Tab>.
4. Select **Setup Password**, alter or delete the existing setup password and press <Enter> or <Tab>.

 **NOTE:** If you change the System and/or Setup password, re-enter the new password when prompted. If you delete the System and/or Setup password, confirm the deletion when prompted.

5. Press <Esc> and a message prompts you to save the changes.
6. Press <Y> to save the changes and exit from the System Setup. The computer reboots.

Disabling a System Password

The system's software security features include a system password and a setup password. The password jumper disables any password(s) currently in use.

 **NOTE:** You can also use the following steps to disable a forgotten password.

1. Follow the procedures in *Before Working on Your Computer*.
2. Remove the cover.
3. Identify the PSWD jumper on the system board.
4. Remove the PSWD jumper from the system board.

 **NOTE:** The existing passwords are not disabled (erased) until the computer boots without the jumper.

5. Install the cover.

 **NOTE:** If you assign a new system and/or setup password with the PSWD jumper installed, the system disables the new password(s) the next time it boots.

6. Connect the computer to the electrical outlet and power-on the computer.
7. Power-off the computer and disconnect the power cable from the electrical outlet.
8. Remove the cover.
9. Replace the PSWD jumper on the system board.
10. Install the cover.
11. Follow the procedures in *After Working on Your Computer*.
12. Power-on the computer.
13. Go to the system setup, and assign a new system or setup password. See *Setting up a System Password*.

Diagnostics

Enhanced Pre-Boot System Assessment (ePSA) Diagnostics

The ePSA diagnostics (also known as system diagnostics) performs a complete check of your hardware. The ePSA is embedded with the BIOS and is launched by the BIOS internally. The embedded system diagnostics provides a set of options for particular devices or device groups allowing you to:

- Run tests automatically or in an interactive mode
- Repeat tests
- Display or save test results
- Run thorough tests to introduce additional test options to provide extra information about the failed device(s)
- View status messages that inform you if tests are completed successfully
- View error messages that inform you of problems encountered during testing



CAUTION: Use the system diagnostics to test only your computer. Using this program with other computers may cause invalid results or error messages.



NOTE: Some tests for specific devices require user interaction. Always ensure that you are present at the computer terminal when the diagnostic tests are performed.

1. Power-on the computer.
2. As the computer boots, press the <F12> key as the Dell logo appears.
3. On the boot menu screen, select the **Diagnostics** option.
The **Enhanced Pre-boot System Assessment** window is displayed, listing all devices detected in the computer. The diagnostics starts running the tests on all the detected devices.
4. If you wish to run a diagnostic test on a specific device, press <Esc> and click **Yes** to stop the diagnostic test.
5. Select the device from the left pane and click **Run Tests**.
6. If there are any issues, error codes are displayed.
Note the error code and contact Dell.

Troubleshooting Your Computer

You can troubleshoot your computer using indicators like Diagnostic Lights, Beep Codes, and Error Messages during the operation of the computer.

Power LED Diagnostics

The power button LED located on the front of the chassis also functions as a bicolored diagnostic LED. The diagnostic LED is only active and visible during the POST process. Once the operating system starts to load, it is no longer visible.

Amber LED blinking scheme – The pattern is 2 or 3 blinks followed by a short pause then x number of blinks up to 7. The repeated pattern has a long pause inserted in the middle.

For example 2,3 = 2 amber blinks, short pause, 3 amber blinks followed by long pause then repeats.

Table 12. Power LED Diagnostics

Amber LED State	White LED State	Description
off	off	system is OFF
off	blinking	system is in sleep state
blinking	off	power supply unit (PSU) failure
steady	off	PSU is working but failed to fetch code
off	steady	system is ON

Amber LED State	Description
2,1	system board failure
2,2	system board failure, PSU or PSU cabling failure
2,3	system board, memory or CPU failure
2, 4	Coin-cell battery failure
2,5	Corrupt BIOS
2,6	CPU configuration failure or CPU failure
2,7	Memory modules are detected, but a memory failure has occurred
3,1	Possible peripheral card or system board failure has occurred
3,2	A possible USB failure has occurred
3,3	No memory modules are detected
3,4	possible system board error has occurred
3,5	Memory modules are detected, but a memory configuration or compatibility error has occurred

Amber LED State	Description
3,6	A possible system board resource and/or hardware failure has occurred
3,7	some other failure with messages on screen

Beep Code

The computer can emit a series of beeps during start-up if the display does not show errors or problems. These series of beeps, called beep codes, identify various problems. The delay between each beep is 300 ms, the delay between each set of beeps is 3 sec, and the beep sound lasts 300 ms. After each beep and each set of beeps, the BIOS should detect if the user presses the power button. If so, BIOS will jump out from looping and execute the normal shutdown process and power system.

Code	1-3-2
Cause	Memory failure

Error Messages

Error Message	Description
Address mark not found	The BIOS found a faulty disk sector or could not find a particular disk sector.
Alert! Previous attempts at booting this system have failed at checkpoint [nnnn]. For help in resolving this problem, please note this checkpoint and contact Dell Technical Support.	The computer failed to complete the boot routine three consecutive times for the same error. Contact Dell and report the checkpoint code (nnnn) to the support technician
Alert! Security override Jumper is installed.	The MFG_MODE jumper has been set and AMT Management features are disabled until it is removed.
Attachment failed to respond	The floppy or hard drive controller cannot send data to the associated drive.
Bad command or file name	Ensure that you have spelled the command correctly, put spaces in the proper place, and used the correct pathname.
Bad error-correction code (ECC) on disk read	The floppy or hard drive controller detected an uncorrectable read error.
Controller has failed	The hard drive or the associated controller is defective.
Data error	The floppy or hard drive cannot read the data. For the Windows operating system, run the chkdsk utility to check the file structure of the floppy or hard drive. For any other operating system, run the appropriate corresponding utility.
Decreasing available memory	One or more memory modules may be faulty or improperly seated. Re-install the memory modules and, if necessary, replace them.
Diskette drive 0 seek failure	A cable may be loose or the computer configuration information may not match the hardware configuration.
Diskette read failure	The floppy disk may be defective or a cable may be loose. If the drive access light turns on, try a different disk.

Error Message	Description
Diskette subsystem reset failed	The floppy drive controller may be faulty.
Gate A20 failure	One or more memory modules may be faulty or improperly seated. Reinstall the memory modules and, if necessary, replace them.
General failure	The operating system is unable to carry out the command. This message is usually followed by specific information—for example, Printer out of paper . Take the appropriate action to resolve the problem.
Hard-disk drive configuration error	The hard drive failed initialization.
Hard-disk drive controller failure	The hard drive failed initialization.
Hard-disk drive failure	The hard drive failed initialization.
Hard-disk drive read failure	The hard drive failed initialization.
Invalid configuration information—please run SETUP program	The computer configuration information does not match the hardware configuration.
Invalid Memory configuration, please populate DIMM1	DIMM1 slot does not recognize a memory module. The module should be re-seated or installed.
Keyboard failure	A cable or connector may be loose, or the keyboard or keyboard/mouse controller may be faulty.
Memory address line failure at address, read value expecting value	A memory module may be faulty or improperly seated. Reinstall the memory modules and, if necessary, replace them.
Memory allocation error	The software you are attempting to run is conflicting with the operating system, another program, or a utility.
Memory data line failure at address, read value expecting value	A memory module may be faulty or improperly seated. Reinstall the memory modules and, if necessary, replace them.
Memory double word logic failure at address, read value expecting value	A memory module may be faulty or improperly seated. Reinstall the memory modules and, if necessary, replace them.
Memory odd/even logic failure at address, read value expecting value	A memory module may be faulty or improperly seated. Reinstall the memory modules and, if necessary, replace them.
Memory write/read failure at address, read value expecting value	A memory module may be faulty or improperly seated. Reinstall the memory modules and, if necessary, replace them.
Memory size in CMOS invalid	The amount of memory recorded in the computer configuration information does not match the memory installed in the computer.
Memory tests terminated by keystroke	A keystroke interrupted the memory test.
No boot device available	The computer cannot find the floppy disk or hard drive.
No boot sector on hard-disk drive	The computer configuration information in System Setup may be incorrect.
No timer tick interrupt	A chip on the system board might be malfunctioning.
Non-system disk or disk error	The floppy disk in drive A does not have a bootable operating system installed on it. Either replace the floppy disk with one that has a bootable operating system, or remove the floppy disk from drive A and restart the computer.

Error Message	Description
Not a boot diskette	The operating system is trying to boot to a floppy disk that does not have a bootable operating system installed on it. Insert a bootable floppy disk.
Plug and play configuration error	The computer encountered a problem while trying to configure one or more cards.
Read fault	The operating system cannot read from the floppy or hard drive, the computer could not find a particular sector on the disk, or the requested sector is defective.
Requested sector not found	The operating system cannot read from the floppy or hard drive, the computer could not find a particular sector on the disk, or the requested sector is defective.
Reset failed	The disk re-set operation failed.
Sector not found	The operating system cannot locate a sector on the floppy or hard drive.
Seek error	The operating system cannot find a specific track on the floppy disk or hard drive.
Shutdown failure	A chip on the system board might be malfunctioning.
Time-of-day clock stopped	The battery might be dead.
Time-of-day not set-please run the System Setup program	The time or date stored in System Setup does not match the computer clock.
Timer chip counter 2 failed	A chip on the system board may be malfunctioning.
Unexpected interrupt in protected mode	The keyboard controller may be malfunctioning or a memory module may be loose.
WARNING: Dell's Disk Monitoring System has detected that drive [0/1] on the [primary/secondary] EIDE controller is operating outside of normal specifications. It is advisable to immediately back up your data and replace your hard drive by calling your support desk or Dell.	During initial startup, the drive detected possible error conditions. When your computer finishes booting, immediately back up your data and replace your hard drive (for installation procedures, see "Adding and Removing Parts" for your computer type). If no replacement drive is immediately available and the drive is not the only bootable drive, enter System Setup and change the appropriate drive setting to None . Then remove the drive from the computer.
Write fault	The operating system cannot write to the floppy or hard drive.
Write fault on selected drive	The operating system cannot write to the floppy or hard drive.

Technical Specifications



 **NOTE:** Offerings may vary by region. For more information regarding the configuration of your computer, click Start  Help and Support, and then select the option to view information about your computer.

Table 13. Processor

Feature	Specification
Processor type	<ul style="list-style-type: none"> • Intel Core i3 series • Intel Core i5 series • Intel Core i7 series • Intel Xeon E3-1200 v2 series
Total Cache	up to 8 MB cache depending on processor type

Table 14. Memory

Feature	Specification
Type	DDR3 NECC and ECC
Speed	1333MHz / 1600 MHz
Connectors	four DIMM slots
Capacity	2 GB , 4 GB, 8 GB
Minimum Memory	2 GB NECC, 4 GB ECC
Maximum memory	16 GB NECC, 32 GB ECC

Table 15. Video

Feature	Specification
Integrated	<ul style="list-style-type: none"> • Intel HD Graphics 2000/2500 (available on select Intel Core processors) • Intel HD Graphics P400 (available on select Intel Xeon processors)
Discrete	<ul style="list-style-type: none"> • PCI Express x16 (wired as x4) graphics adapter • PCI Express x16 graphics adapter

Table 16. Audio

Feature	Specification
Integrated	two channel high definition audio

Table 17. Network

Feature	Specification
Integrated	Intel 82579LM ethernet capable of 10/100/1000 Mb/s communication

Table 18. System Information

Feature	Specification
System Chipset	Intel C216 chipset
DMA Channels	two 82C37 DMA controllers with seven independently programmable channels
Interrupt Levels	Integrated I/O APIC capability with 24 interrupts
BIOS Chip (NVRAM)	12 MB

Table 19. Expansion Bus

Feature	Specification
Bus Type	PCI, PCIe gen2, gen3 (x16), USB 2.0, and USB 3.0
Bus Speed:	PCI: <ul style="list-style-type: none"> • 133 MB/s PCI Express: <ul style="list-style-type: none"> • x1-slot bidirectional speed – 500 MB/s • x16-slot bidirectional speed – 16 GB/s USB: <ul style="list-style-type: none"> • USB 3.0 – 5 GB/s • USB 2.0 – 480 GB/s

Table 20. Cards

Feature	Specification
PCI slot	supports full-height card
PCI Express x1 slot	supports full-height PCIe x1 cards
PCI-Express x16 slot	supports full-height PCIe x16 Gen3 cards
PCI-Express x16 (wired as x4) slot	support full-height cards, PCIe x1 or PCIe x4.

Table 21. Drives

Feature	Specification
Externally Accessible	
5.25-inch drive bays	two
Internally accessible	
USB 2.0:	
3.5-inch SATA drive bays	two
2.5-inch SATA drive bays (using interposer in 3.5" bay)	four

Table 22. External Connectors

Feature	Specification
Audio:	
front panel	two connectors for microphone and headphone
back panel	two connectors for line-out and line-in/microphone
Network Adapter	one RJ-45 connector
Serial	one 9-pin connector; 16550 C compatible
Parallel	one 25-pin connector (optional for mini-tower and desktop)
USB 2.0:	
front Panel	two
back Panel	four
USB 3.0:	
front Panel	two
back Panel	two
Video	one 15-pin VGA connector (x1), 20-pin DisplayPort connector (x2)



NOTE: Video connectors may vary based on the graphics card selected.

Table 23. System Board Connectors

Feature	Specification
PCI 2.3 data width (maximum) — 32 bits	one 120-pin connector
PCI Express x1 data width (maximum) — one PCI Express lane	one 36-pin connector
PCI Express x16 (wired as x4) data width (maximum) — four PCI Express lanes	one 164-pin connector

Feature	Specification
PCI Express x16 data width (maximum) — 16 PCI Express lanes	one 164-pin connector
Serial ATA	four 7-pin connectors
Memory	four 240-pin connectors
Internal USB	one 10-pin connector
System Fan	one 5-pin connector
Front panel control	one 6 pins and two 20 pins connectors
Thermal Sensor	one 2-pin connector
Processor	one 1155-pin connector
Processor Fan	one 5-pin connector
Service mode jumper	one 2-pin connector
Password clear jumper	one 2-pin connector
RTC reset jumper	one 2-pin connector
Internal speaker	one 5-pin connector
Intruder connector	one 3-pin connector
Power connector:	one 24-pin and one 4-pin connector

Table 24. Controls and Lights

Feature	Specification
Front of the computer:	
Power button light	White light — Solid white light indicates power-on state; blinking white light indicates sleep state of the computer.
Drive activity light	White light — Blinking white light indicates that the computer is reading data from or writing data to the hard drive.
Back of the computer:	
Link integrity light on integrated network adapter	Green — a good 10 Mbps connection exists between the network and the computer. Orange — a good 100 Mbps connection exists between the network and the computer. Yellow — a good 1000 Mbps connection exists between the network and the computer. Off (no light) — the computer is not detecting a physical connection to the network.
Network activity light on integrated network adapter	Yellow light — A blinking yellow light indicates that network activity is present.

Feature	Specification
Power supply diagnostic light	Green light — The power supply is turned on and is functional. The power cable must be connected to the power connector (at the back of the computer) and the electrical outlet.
	 NOTE: You can test the health of the power system by pressing the test button. When the system power supply voltage is within specification, the self-test LED lights up. If the LED does not light up, the power supply may be defective. AC power must be connected during this test.

Table 25. Power

Feature	Specification
Coin-cell battery	3 V CR2032 lithium coin cell
Voltage	100 VAC to 240 VAC, 50 Hz to 60 Hz, 5.0 A
Wattage	275 W/320 W
Maximum heat dissipation	4774.00 BTU/hr

 **NOTE:** Heat dissipation is calculated by using the power supply wattage rating.

Table 26. Physical

Feature	Specification
Height	360 mm (14.17 inches)
Width	175 mm (6.89 inches)
Depth	435 mm (17.13 inches)
Weight	9.24 kg (20.35 lb)

Table 27. Environmental

Feature	Specification
Temperature range:	
Operating	10 °C to 35 °C (50 °F to 95 °F)
Storage	–40 °C to 65 °C (–40 °F to 149 °F)
Relative humidity (maximum):	
Operating	20% to 80% (non-condensing)
Storage	5% to 95% (non-condensing)
Maximum vibration:	
Operating	0.26 GRMS

Feature	Specification
Storage	2.2 GRMS
Maximum shock:	
Operating	40 G
Storage	105 G
Altitude:	
Operating	-15.2 m to 3048 m (-50 ft to 10,000 ft)
Storage	-15.2 m to 10,668 m (-50 ft to 35,000 ft)
Airborne contaminant level	G1 or lower as defined by ANSI/ISA-S71.04-1985

Contacting Dell

To contact Dell for sales, technical support, or customer service issues:

1. Visit support.dell.com.
2. Verify your country or region in the **Choose a Country/Region** drop-down menu at the bottom of the page.
3. Click **Contact Us** on the left side of the page.
4. Select the appropriate service or support link based on your need.
5. Choose the method of contacting Dell that is convenient for you.